

CUSTOMER TERMINAL	ROHS	Lead(Pb)-free
	YES	YES

1. Mechanical Dimensions

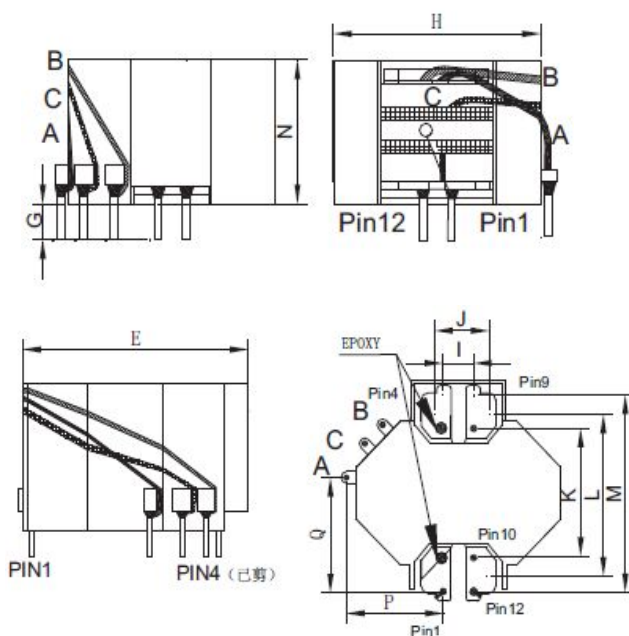

G	3.5	±0.5
E	32.0	MAX
H	35.0	MAX
N	22.0	MAX
I	3.6	±0.3
J	7.2	±0.3
K	18.0	±0.4
L	21.6	±0.4
M	25.2	±0.4
Q	15.7	±0.4
P	15.6	±0.4

2. Schematic Diagram

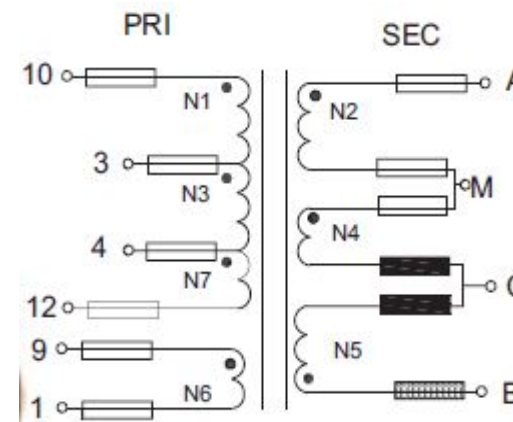

3. Material List

Core:FW44 RM10

Bobbin:FWB1005(6+6PIN)

Wire:2UEW TIW

Copper foil: 0.025t*5.0/8.0mm

Operating Temperature: -30 to115 °C

4. Electrical Specification

Inductance : $L(10-12):370\pm5\%uH$ 70KHZ , 1.0V

Leakage inductance: 6uH MAX 70KHZ , 1.0V

DCR : $(12-10)=0.216\Omega$ MAX

Hi-Pot:P-S: AC 60Hz 4000V 1mA 3S

S-CORE:AC 60Hz 4000V 1mA 3S

REV.	DATE	<p>Convention Placement</p>	DRW.	Drawing Title:	Part No:		
0	00/00		CHK.			TRANSFORMER	FWPTRM10V371J
			APP.			Customer P/N	Specification Sheet 1of 1
ROHS		www.ferriwo.com					